

C4099

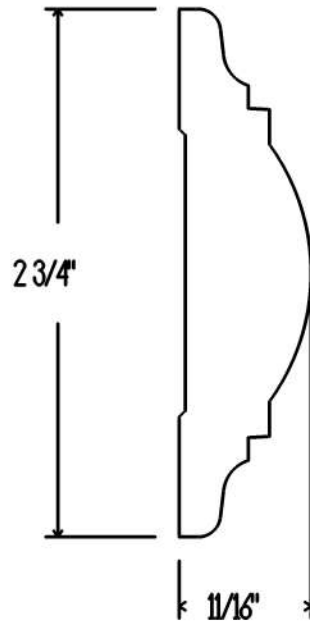

Date: 10/18/07

Drawn By: RL

Approved By: _____

Approved By: _____

Full Scale

Page: of