

CS2158

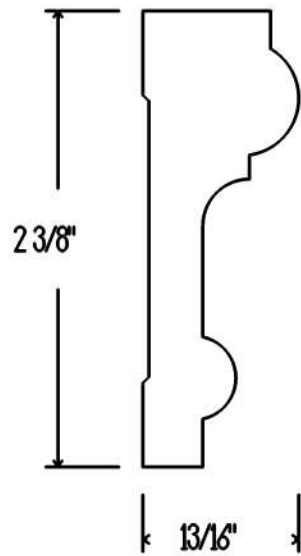

EF. San Juan, Inc

Date: 7/22/09

Drawn By: RL

Approved By: _____

Approved By: _____

Page: of

Full Scale