

CS2212

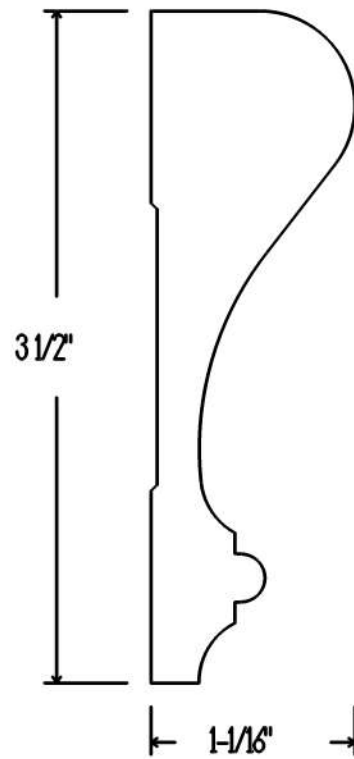

EF. San Juan, Inc

Date: 2/2/10

Drawn By: RL/BS

Approved By: _____

Approved By: _____

Page: of

Full Scale