

CS2094

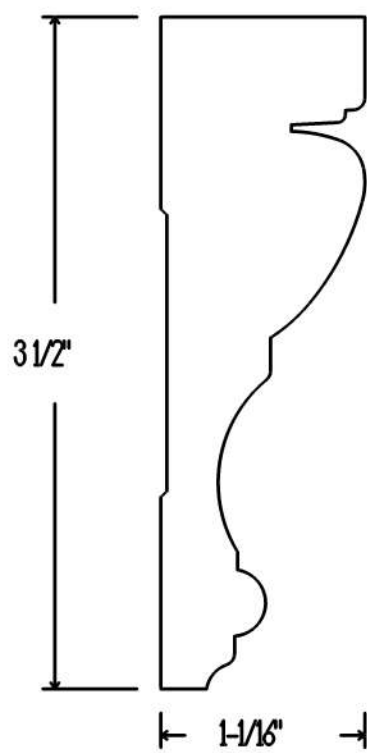

Date: 8/4/08

Drawn By: RL

Approved By: _____

Approved By: _____

Full Scale

Page: of