

CS2023

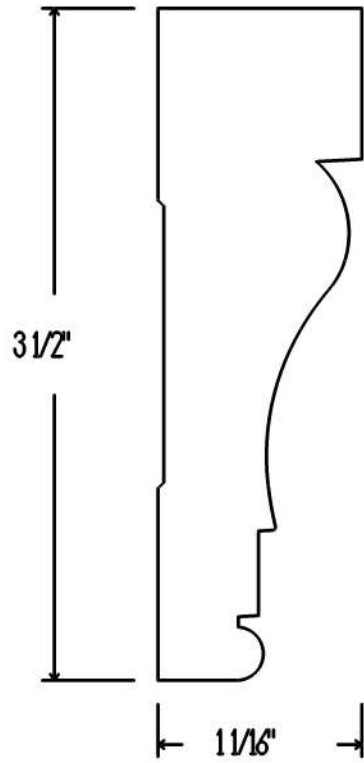

Date: 2/21/08

Drawn By: RL

Approved By: _____

Approved By: _____

Full Scale

Page: of